

Since 1968

COMMAX
SmartHome & Security

User Manual

Color video door phone CDV-43Q



www.commax.com

COMMAX Co.,Ltd.



- Thank you for purchasing COMMAX products.
- Please carefully read this User's Guide (in particular, precautions for safety) before using a product and follow instructions to use a product exactly.
- The company is not responsible for any safety accidents caused by abnormal operation of the product.



Greetings

- Thank you for choosing COMMAX.
- Please read this manual carefully before you use the product.



Table of contents

Greetings	1
Contents table	1
1. Warnings and caution	2
2. Part names and functions	4
3. How to use the products	5
4. Settings	6
5. Installation and Wiring	8
6. Wiring Diagram	9
7. Package Contents	11
8. Caution in use	12
9. Miscellaneous	12
10. Specification.....	12



1. Warnings and caution

Please follow the things described below in order to prevent any danger or property damage.

	Warning	It may cause a serious damage or injury if violated.		Prohibition.
	Caution	It may cause a minor damage or injury if violated.		No disassembly
				No touch
				Must follow strictly.
				Shows plugging out the power cord without an exception
				Shows the warning and caution for an electric shock.
				Shows the warning and caution for a fire.

Warning

Power & Installation

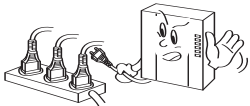
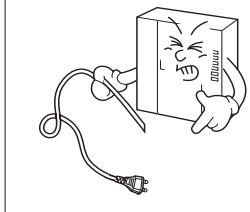
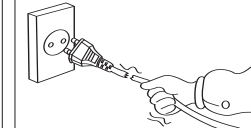
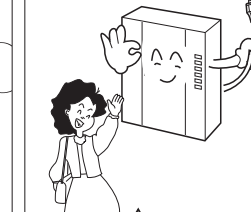
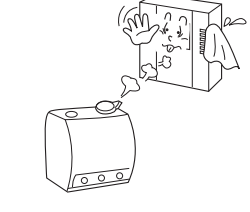
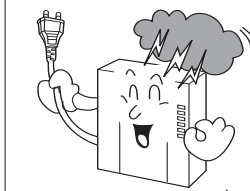
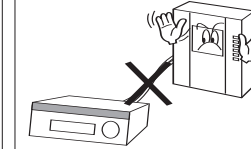
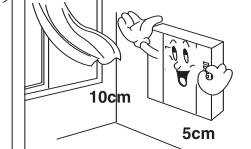
<p>Please don't use several products at the same time on one power socket.</p> <ul style="list-style-type: none"> It may cause a fire due to an abnormal overheating.  <p> </p>	<p>Please don't bend the power cable excessively or it may cause an electric shock.</p> <ul style="list-style-type: none"> fire when using a damaged power cable.  <p> </p>	<p>Please don't handle the power cable with a wet hand.</p> <ul style="list-style-type: none"> It may cause an electric shock.  <p> </p>	<p>Please plug out the power cable from the socket when not using it for a long period of time.</p> <ul style="list-style-type: none"> It may shorten the product lifespan or cause a fire.  <p> </p>
<p>Please don't install the product in the place where there is much oil, smoke or humidity.</p> <ul style="list-style-type: none"> It may cause an electric shock or fire.  <p> </p>	<p>Please don't install the product with the lightning and thunder.</p> <ul style="list-style-type: none"> It may cause an electric shock or fire.  <p> </p>	<p>Please don't use and connect this product with other products with different rated voltage.</p> <ul style="list-style-type: none"> It may cause a disorder or fire.  <p> </p>	<p>When installing the product that generates heat, please install the product away from the wall (10cm) for the ventilation.</p> <ul style="list-style-type: none"> It may cause a fire due to the increased internal temperature.  <p> </p>

! Warning

Cleaning & Use

Please don't disassemble, repair or rebuild this product arbitrarily (please contact the service center if a repair is needed).

- It may cause an electric shock or fire.

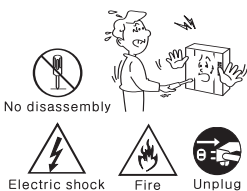

If an abnormal sound, burning smell or smoke is coming out of the product, please plug out the power cable and contact a service center.

- It may cause an electric shock or fire.

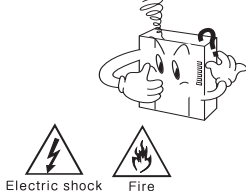

Please don't insert any metallic or burnable materials into the ventilation hole.

- It may cause an electric shock or fire.

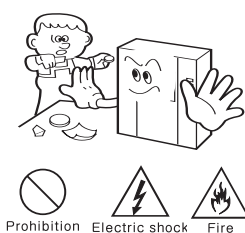

Please use only the designated batteries for the products of using DC power.

- It may cause an electric shock or fire.

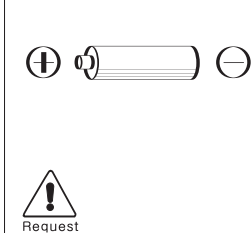

! Caution

Power & Installation

Please plug the power cable firmly into the inner end

- It may cause a fire.

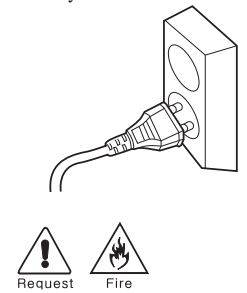

Please hold the plug tightly when unplugging the power cable (a part of the copper wire may be disconnected if the grabbing is only made on the cord when pulling out the cable).

- It may cause an electric shock or fire

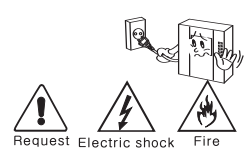

When connecting the power cables after cutting the cable, please install the product with power off

- It may cause an electric shock or fire

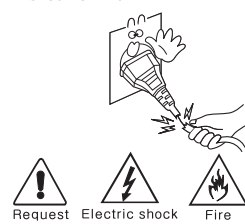

When installing the product, please fix it firmly while using the wall-mounting unit and screws.

- It may cause an injury from the falling object.

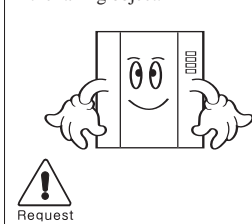

Please be careful when using an AC circuit breaker since there is a possibility of an electric shock.

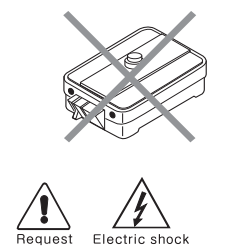

Please check the use voltage and current for the DC-only products and use the appropriate rectifier.

- It may cause a fire.

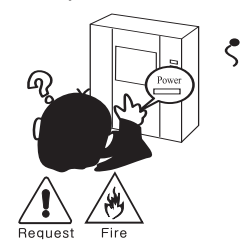

Please avoid direct rays of the sun or heating devices at a time of installation.

- It may cause a fire.

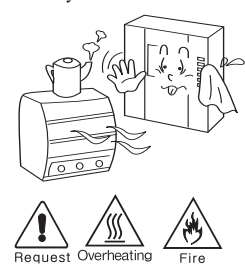

Please don't install the product on an unstable place or small support board.

- It may cause an injury if it falls down while in use.

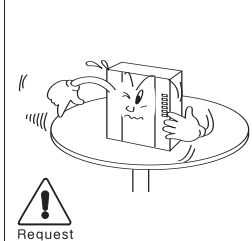

Cleaning & Use

When cleaning the product, please rub it with a soft and dry cloth after plugging out the power cable. (Please don't use any chemical products such as wax, benzene, alcohol or cleanser.)



Please don't drop the product on the ground and don't apply a shock.

- It may cause a failure.

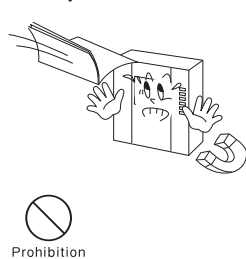

Please use the designated connection cable within the maximum calling distance designated for the product

- It may reduce the product performance.

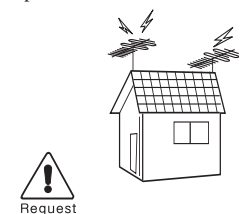

2. Part names and functions

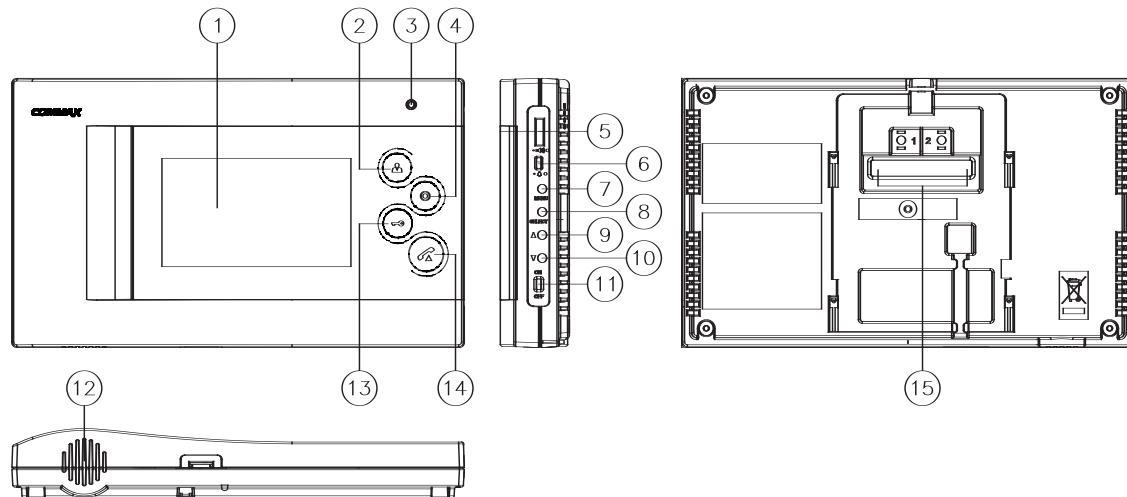

No.	Contents	No.	Contents	No.	Contents
1	Monitor	7	MENU button	13	Door release button
2	Monitor button	8	SELECT button	14	Talk button / POWER LED
3	Mike	9	UP button	15	External connections
4	Interphone button	10	DOWN button		
5	Call Volume	11	Power button		
6	Tones Volume	12	Speaker		



3. How to use the products

4-1. Visitor calls from entrance

- ① When a visitor presses CALL button at entrance, the chime melody rings and visitor image is shown on the screen.
- ② Press TALK button to talk with the visitor and you can open the door by pressing DOOR RELEASE button. (DOOR RELEASE function is only possible during talking mode and CAMERA with door release function should be interlocked.)
- ③ By picking up the handset of additional interphone, 3-way communication is possible. (Simultaneous communication mode)
- ④ To finish talking, press TALK button again while you are talking with the visitor.

4-2. Talking with interphone

(1) Calls from interphone

- ① You can hear chime bell if someone calls you by interphone.
- ② You can talk with person by pressing interphone button.
- ③ When Visitor calls from door camera while household is talking with interphone, Image from door camera will be shown on the screen of household video phone with calling sound. 3-way communication is also possible between household, interphone and door camera.

(2) To call the interphone

- ① If you press interphone button on the monitor, you can call the interphone. (It is possible only during pressing the interphone button.)
- ② You can talk with interphone if someone answers.

4-3. Monitoring : function to see the image of visitor in the entrance.

(stand-by mode) Operation

- By pressing the Monitor button repeatedly, the monitor will work as following in order.
Camera 1 → (Camera 2) → OFF → Camera 1

(On talking mode) Operation

- By pressing Monitor button repeatedly, the monitor will work as following in order.
Camera1 → (Camera 2) → Camera 1 → (Camera 2)



4. Settings

- You can adjust DOOR VIDEO SET, UTILITY and check INFORMATION(model name & version) with (UP)△ / (DOWN)▽ button after pressing Menu button on the right of the product in video talk mode or stand-by mode.

- **Products settings need the following 4 buttons on the right of product.**

- * Start Menu / Exit : MENU button
- * Select and in-put : SELECT button
- * Move up / Move right : △(UP button)
- * Move down / Move left : ▽(DOWN button)

4-1. Screen setting (Brightness/Contrast/Color adjustment function)

Press the Menu button and access to DOOR VIDEO SET and enter the setting menu by pressing SELECT button.

(1) BRIGHTNESS : Adjusting Brightness of Screen

(2) CONTRAST : Adjusting Contrast of Screen

(3) COLOR : Adjusting Color of Screen

※ How to adjust

- ① Move to Menu you want to adjust with △/▽ button on the list of DOOR VIDEO SET
- ② Press SELECT button to choose an icon.
- ③ Adjust the set value with △/▽ button
- ④ To complete the set, press SELECT button.

(4) RESET : Initializing

※ How to Reset

- ① Move to RESET menu in DOOR VIDEO SET menu
- ② Press SELECT to enter the menu.
- ③ Select YES with △/▽ button
- ④ Press SELECT button.

(5) EXIT : Go back to setting mode

4-2. UTILITY(additional function)

Press the Menu button and access to Utility SET and enter the menu by pressing SELECT button.

(1) CHIME-BELL MUTE : setting mute sound

- ① Move to CHIME-BELL MUTE icon with △ /▽ button in UTILITY Menu.
- ② Press SELECT to enter the menu.

③ Select the mute sound or not with Δ/∇ button.



④ To complete the set, press SELECT button.

(2) SCREEN MODE : to set for screen ratio

① ZOOM: Zoon in(expansion) image maintaining actual ratio(4:3) is shown. (full of the screen)

② 4:3: Image of 4:3 ratio without expansion is shown.(This is actual ratio for camera)

③ WIDE: Full of the screen. Not actual ratio (4:3). Image is expanded according to LCD (WIDE LCD) ratio.

※ How to adjust

① Access to SCREEN MODE with Δ/∇ button in UTILITY Menu

② Press SELECT button to enter the menu.

③ Adjust screen ratio value with Δ/∇ button.

④ To complete the set, press SELECT button.

(3) EXIT : Go back to Setting menu

4-3. INFORMATION (The function to check Model name & Version)

In order to check the product information, press menu button and move to INFORMATION menu with Δ/∇ button.

(1) Model : You can check the model name.

(2) Version : You can check the model version.

(3) VIDEO : You can check the video transmission formats(NTSC/PAL)

(4) SOURCE : You can check the position of camera(DOOR1 / DOOR2) which is shown on the screen for now.

4-4. EXIT(Finish setting menu)

5. Installation and Wiring

1. Installation Method of camera monitor

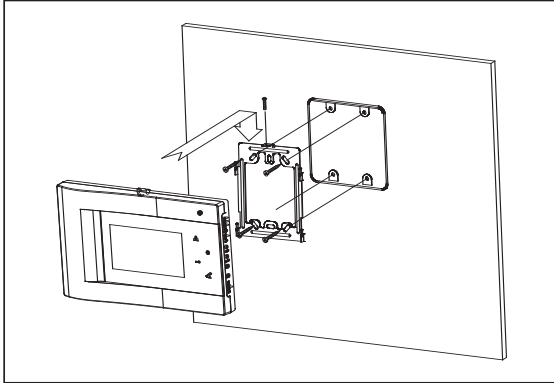

Caution

- ① Avoid the range of direct sunlight
- ② The suitable height is 1,450~1,500mm from the floor
- ③ Avoid installing the product in the place with strong magnetism and much gas or humidity

2. Installation Method of camera

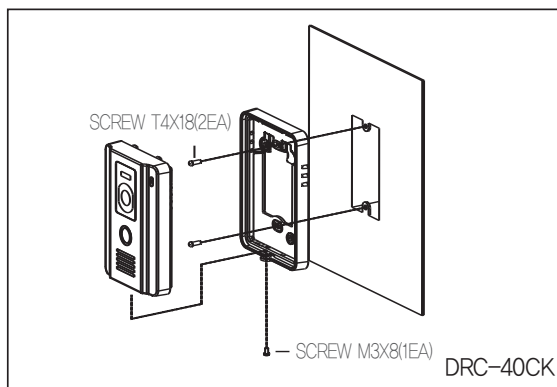

Caution

- ① Avoid the range of back light or direct sunlight
- ② Keep cleaning up its lens to capture good views.

6. Wiring Diagram

Please install as the wiring diagram described below

※ Polarity of Camera connector

① RED : VOICE ② BLUE : GND ③ YELLOW : POWER(+12V) ④ WHITE : VIDEO SIGNAL

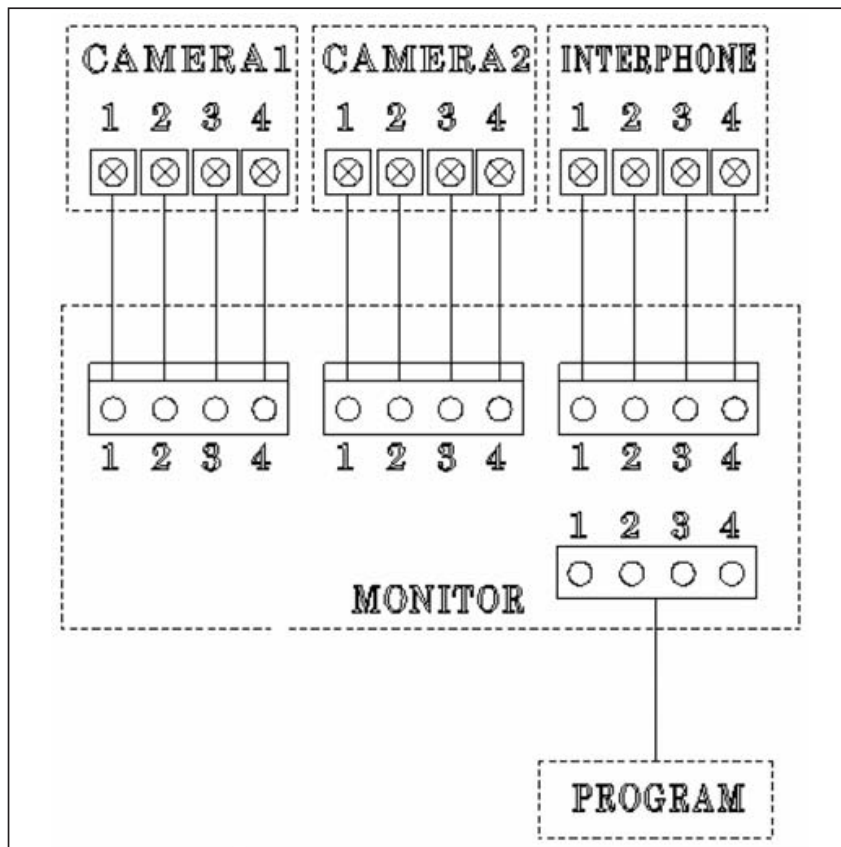

Wiring precautions

Each device should be connected by separated cables.

If you use UTP CABLE[CAT.5] for Camera1 and Camera2, 2 lines of UTP CABLE are required.

DOOR Camera Wiring

If you use UTP CABLE[CAT.5], connect the rest 4 lines to GND after connecting 4 lines between Monitor and interphone.

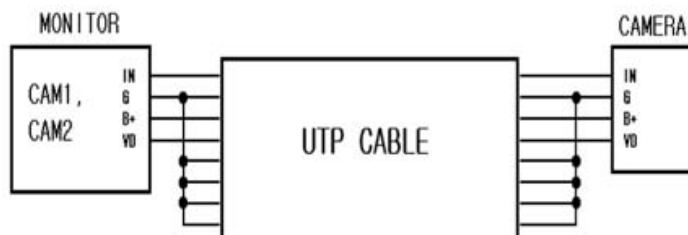

INTERPHONE Wiring

If you use UTP CABLE[CAT.5], connect the rest 4 lines to GND after connecting 4 lines between Monitor and interphone.

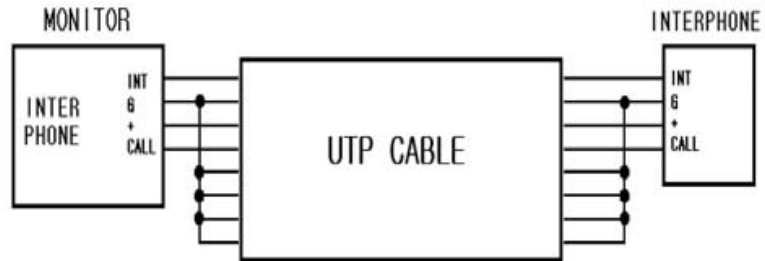

7. Package Contents

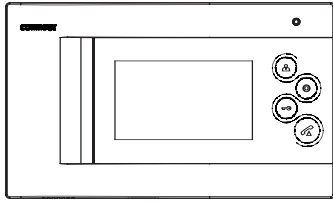

Monitor (CDV-43Q)

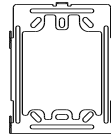

Wall Bracket

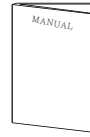

Manual

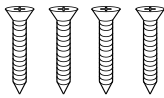

(T)4 X 18mm
Wall bracket
mounting screw
(4EA)



(M)3 X 6mm
Monitor fixing
screw
(1EA)

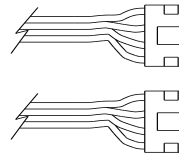

4P X 300(2EA)
Connector



8. Caution in use

1. Turn on the power switch.
2. Please contact your local agent for product maintenance when you have a problem in use of CDV-43Q
3. For your safety, power switch with a safety device must be used in your building.
4. Unplug before installing or repairing the product.
5. Unplug when you connect monitor with door cameras.



9. Miscellaneous

- Please carefully read this User's Guide before calling service man
After checking the entire check list, please contact customer service center.
We will do our best to make you satisfy with our services.



10. Specification

Spec	Model	CDV-43Q
Wiring		Door camera 4 wires(polar), Interphone 4 wires (polar)
Rating voltage		100V-240V~, 50/60Hz (FREE VOLTAGE)
Power consumption		standby : 4.5W maximum : 10W
Communication way		HANDS FREE (Voice switch circuit)
Monitor		4.3" TFT-DIGITAL LCD
Call sound		- Entrance : electronic chime(3tone 2hit(Sol-Mi-Do) - Interphone : electronic oscillations
Video receiving time		Monitoring mode : 30 °±5sec, Talking mode: 60 ±5sec
Distance		28m(∅ 0.5) / 50m(∅ 0.65) / 70m(∅ 0.8)
Working temperature		0 ~+40°C(32°F ~ 104°F)
Dimension		235.5(W) X 140(H) X 36(D) mm

COMMAX

COMMAX Co.,Ltd.

513-11, Sangdaewon-dong, Jungwon-gu, Seongnam-si, Gyeonggi-do, Korea

Int'l Business Dept. Tel. : +82-31-7393-540~550 Fax. : +82-31-745-2133

Web site : www.commax.com

PM0743Q00011

Printed In Korea / 2012.11.104